

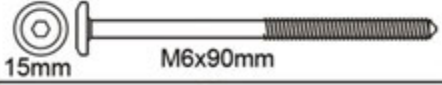









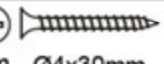
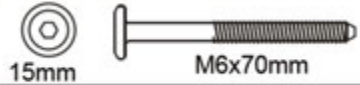

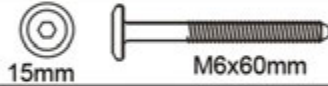
HARDWARE

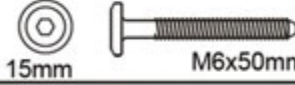
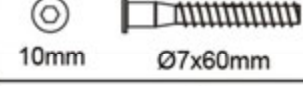
A	 15mm M6x90mm	38	I	 Ø8x30mm	44
B		40	J	 8mm Ø4x30mm	78
C	 15mm M6x70mm	02	K	 Ø8mm	13
D	 15mm M6x25mm	06	L	 15mm M6x60mm	02
E	 15mm M8x20mm	10	M	 15mm M6x50mm	02
F	 10mm Ø7x60mm	20	N		02
G		02	O	 8mm Ø4x16mm	04
H	 Ø12x80mm	04	P	 12mm M6x70mm	14

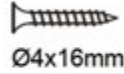

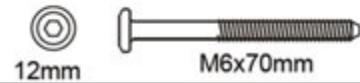
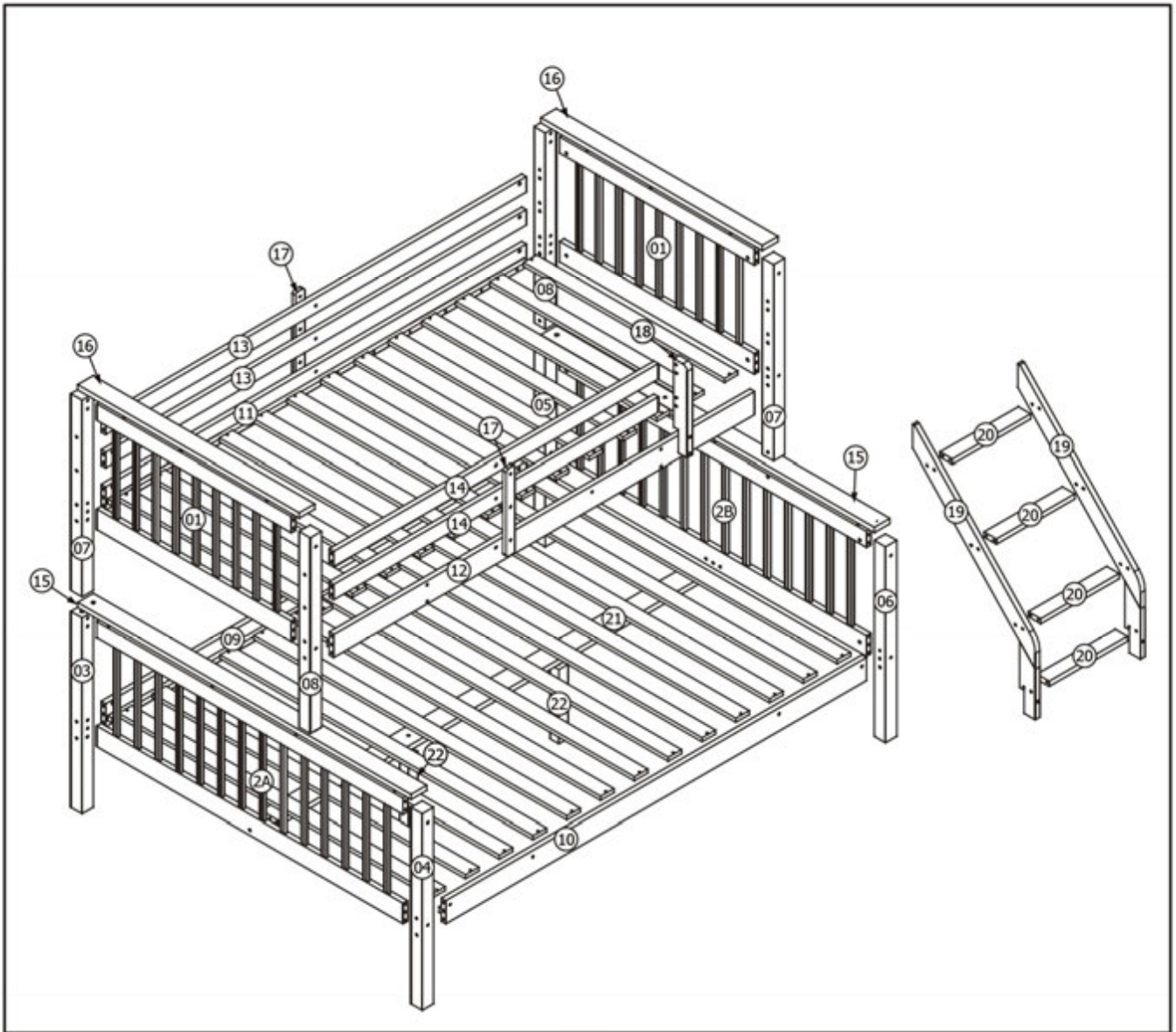
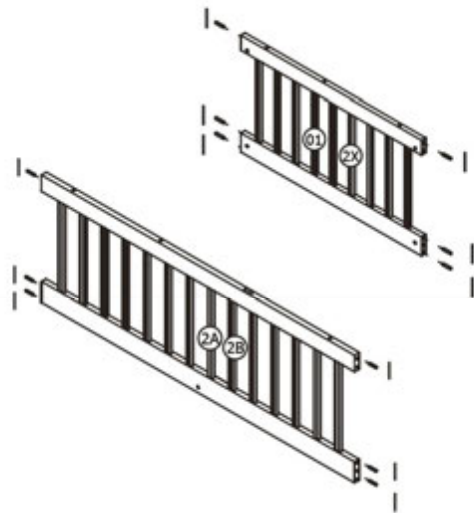
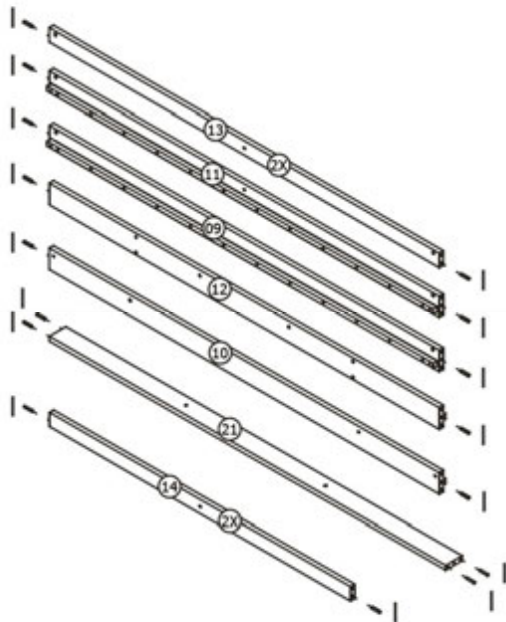

01

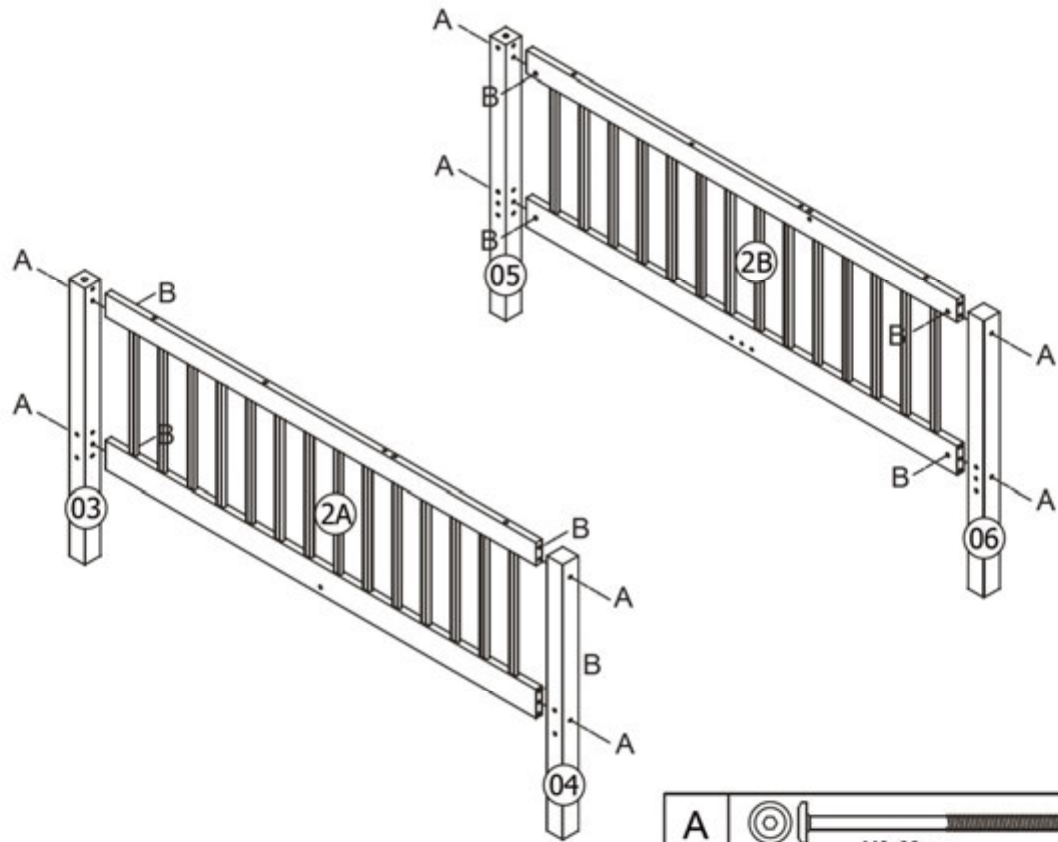

	 Ø8x30mm	44
--	--	----

02



A	 M6x90mm	08
B		08

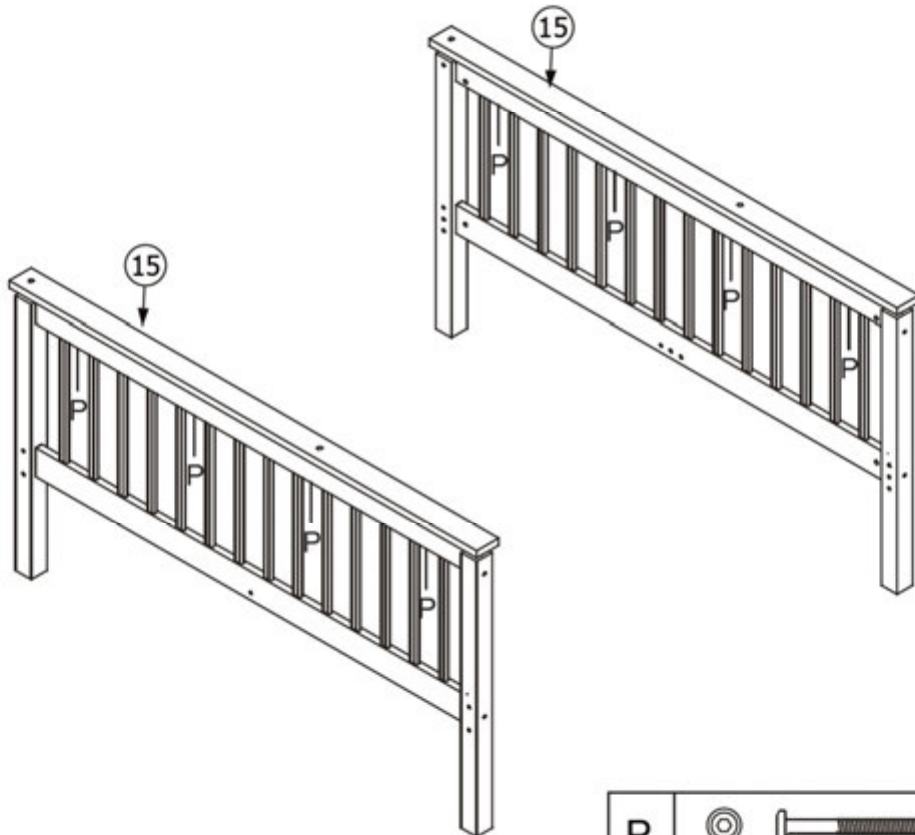

03

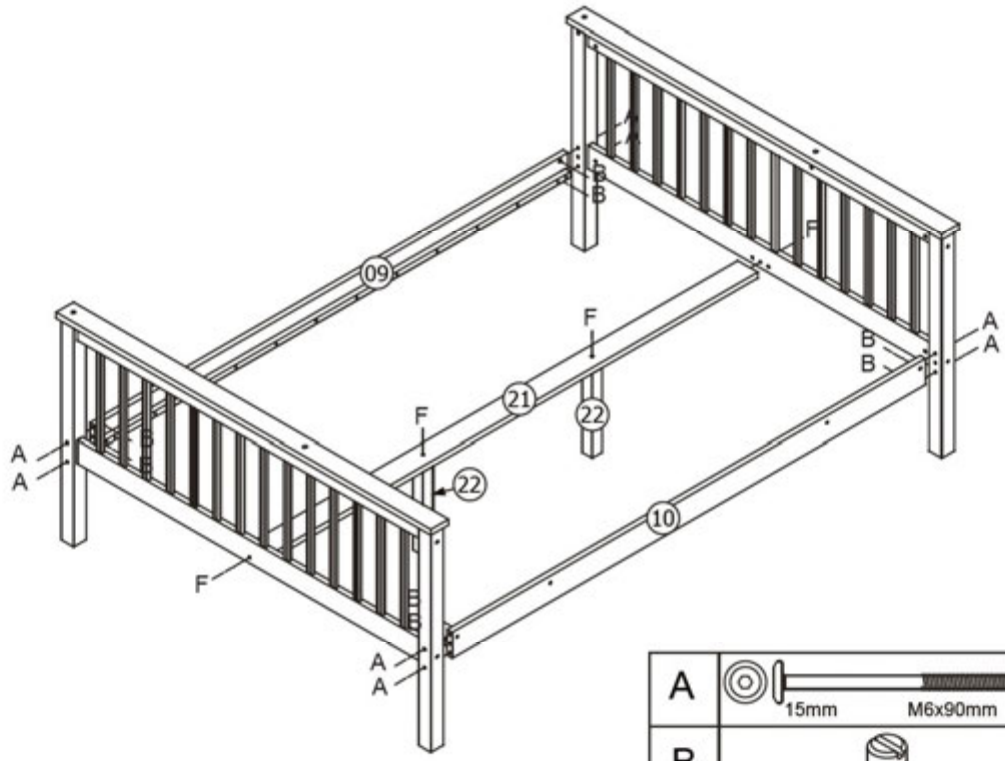

P	 12mm M6x70mm	08
---	--	----

04



A	 15mm M6x90mm	08
B		08
F	 10mm Ø7x60mm	03

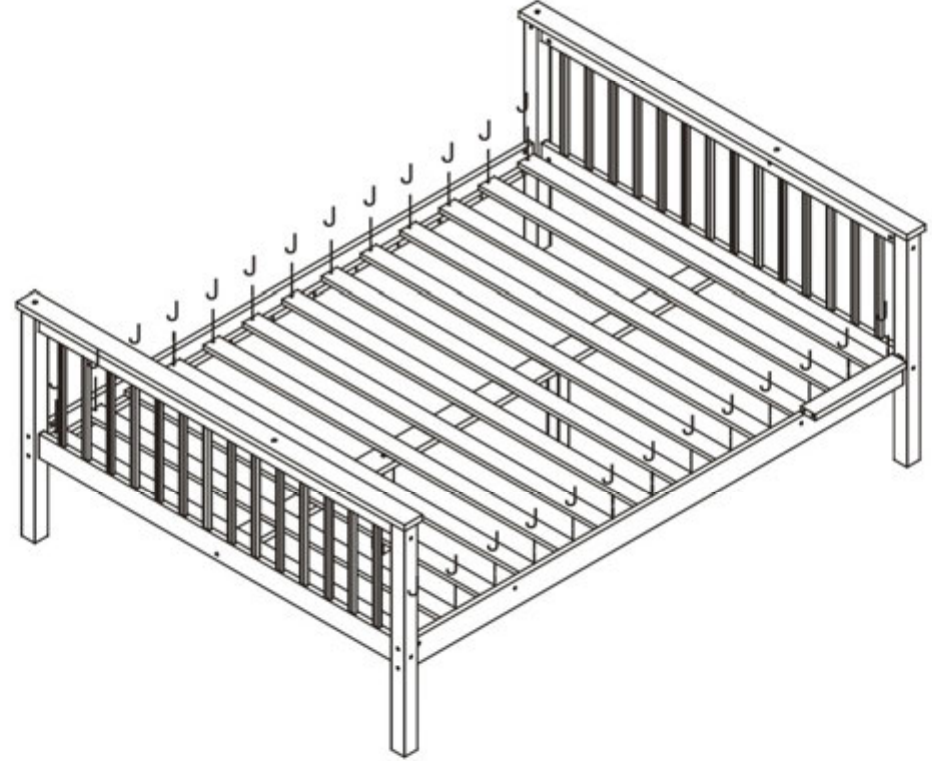

05



J	 8mm Ø4x30mm	48
---	---	----

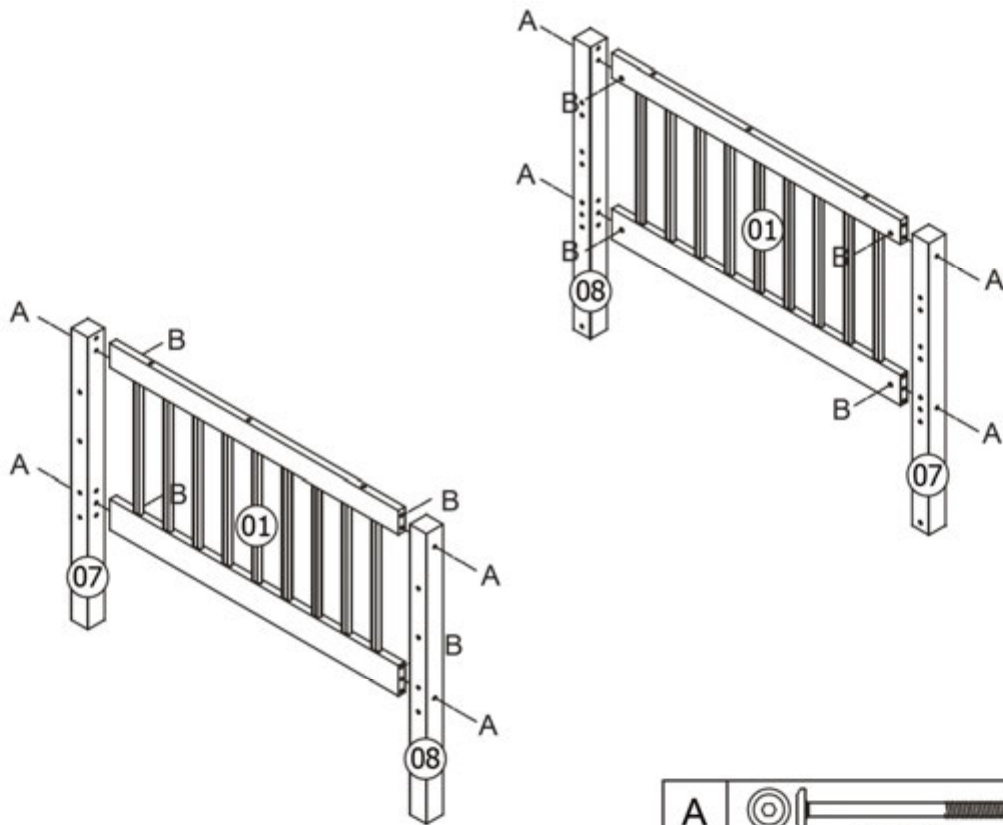

06



A	  M6x90mm	08
B		08

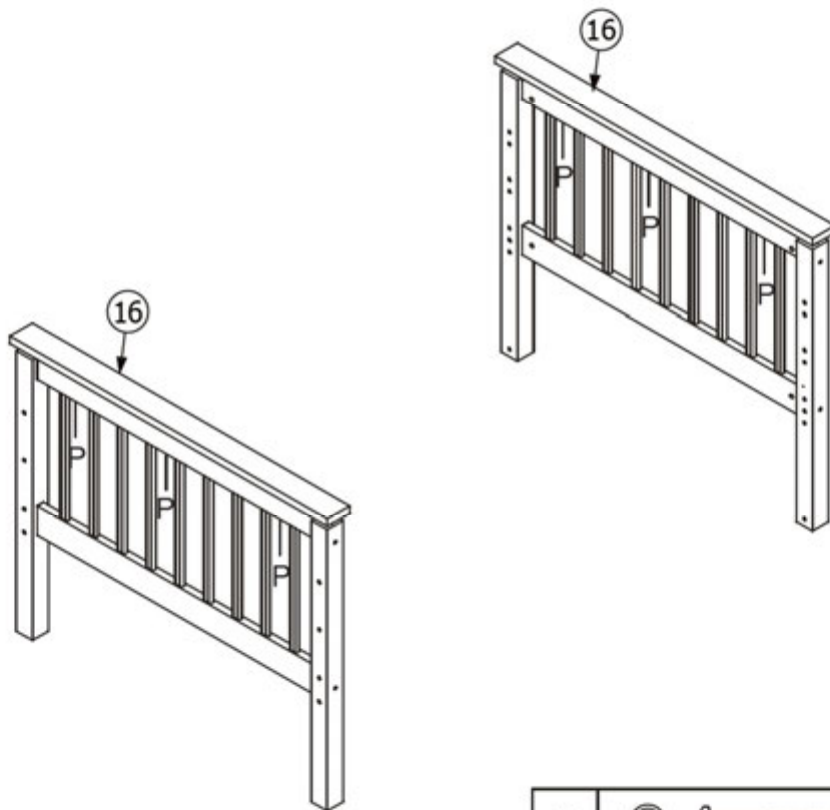





07

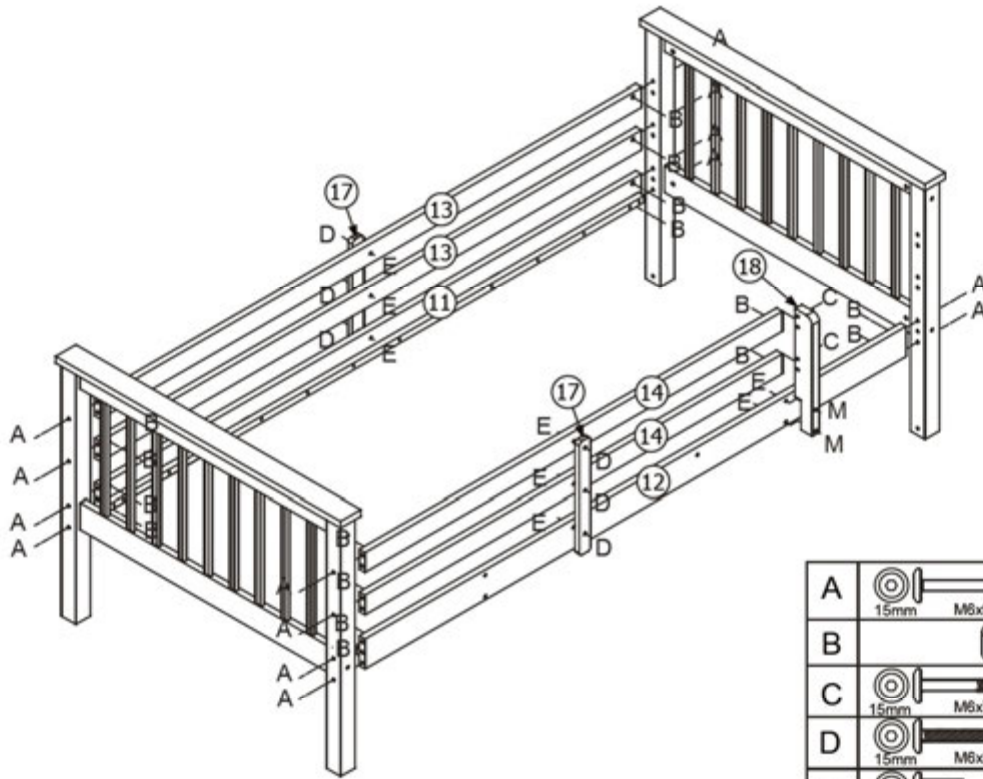

P	  12mm M6x70mm	06
---	---	----

08



A	 15mm M6x90mm	14
B		16
C	 15mm M6x70mm	02
D	 15mm M6x25mm	06
E	 15mm M8x20mm	08
M	 15mm M6x50mm	02

09

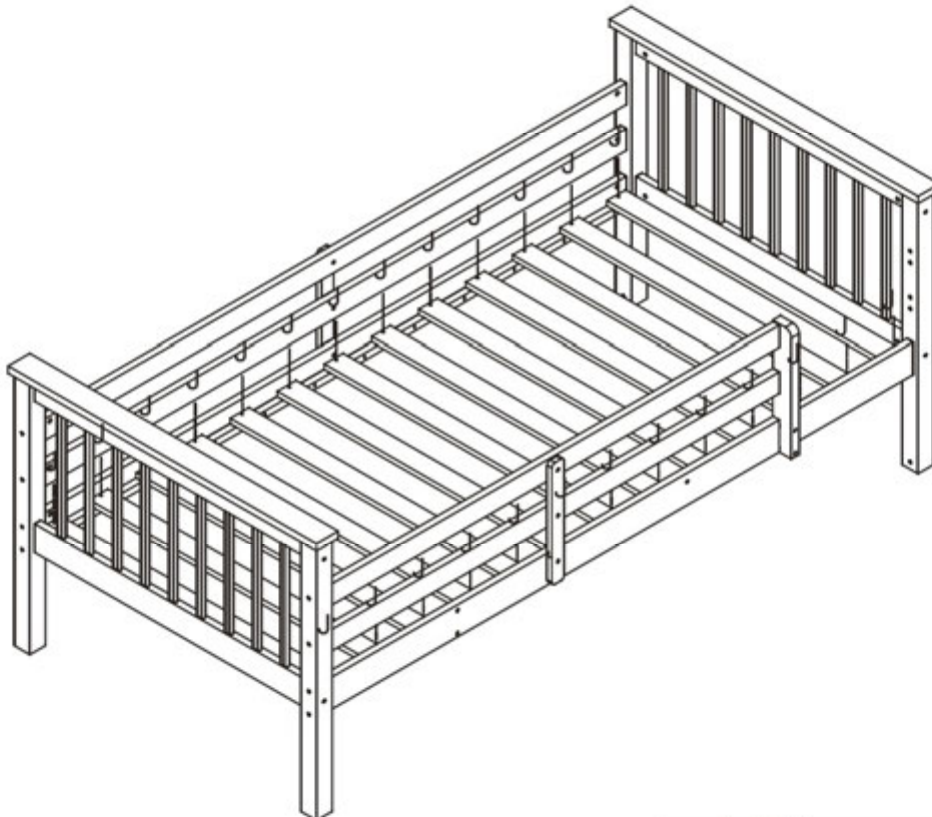

J  8mm Ø4x30mm

30

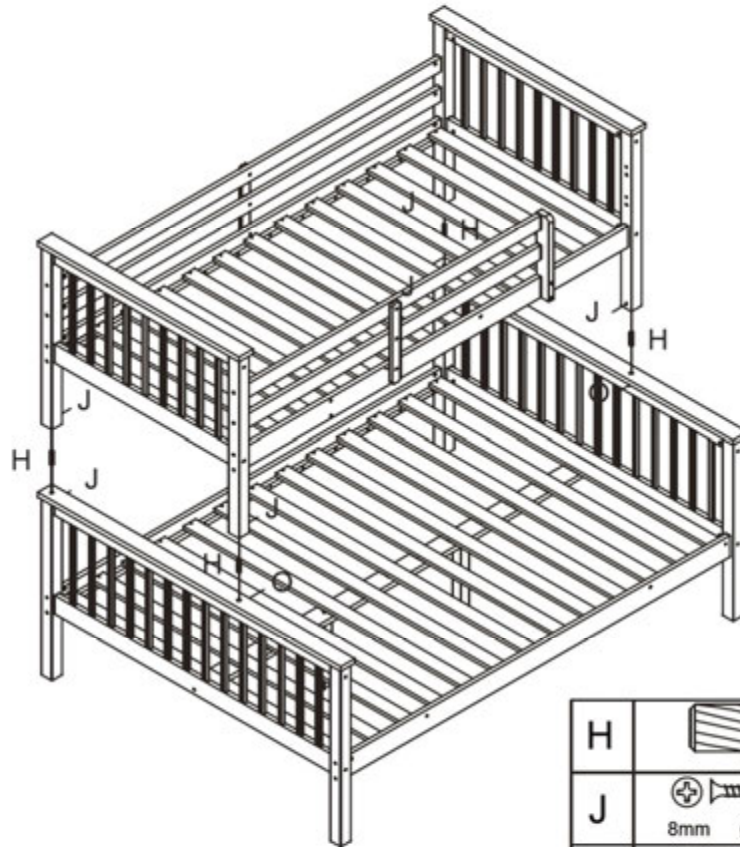

10

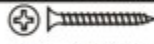
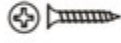

H	 Ø12x80mm	04
J	 8mm Ø4x30mm	06
O	 8mm Ø4x16mm	02

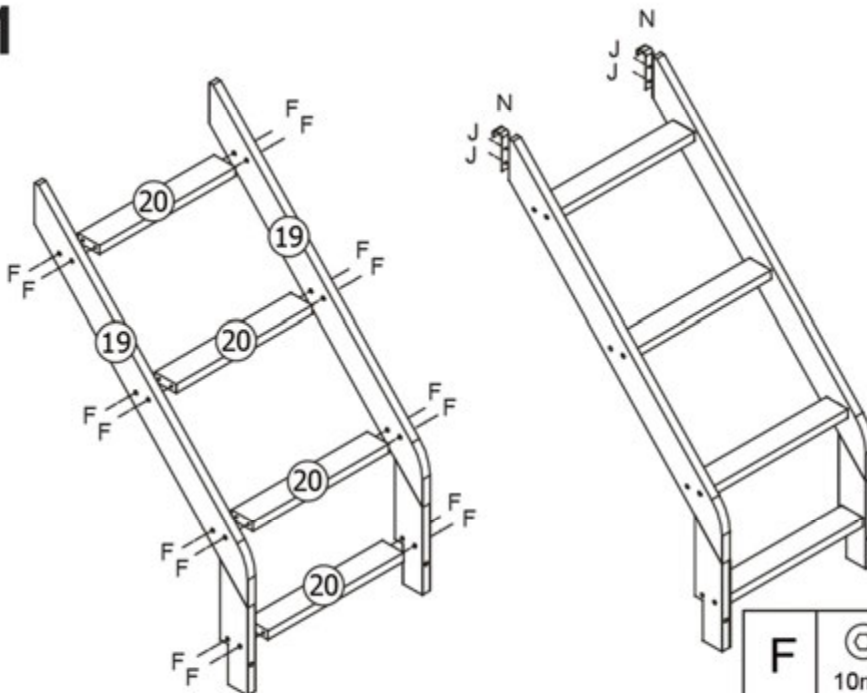

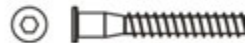



11

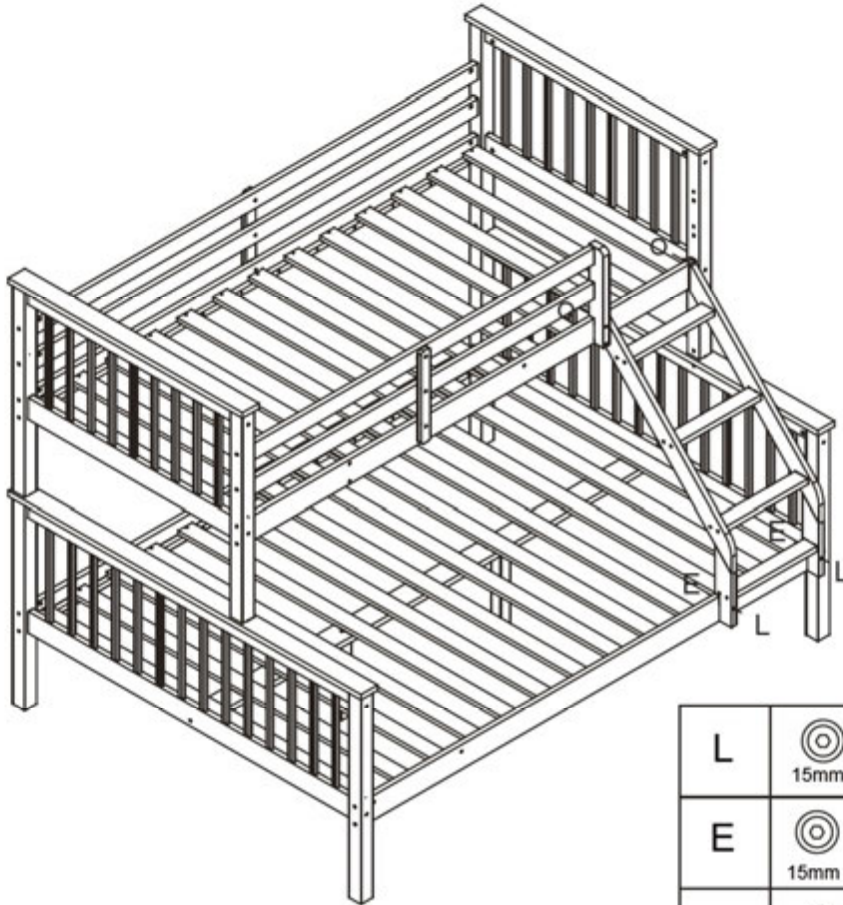

F	 10mm Ø7x60mm	16
N		02
J	 8mm Ø4x30mm	04

12



L	 15mm	 M6x60mm	02
E	 15mm	 M8x20mm	02
O	 8mm	 Ø4x16mm	02

13

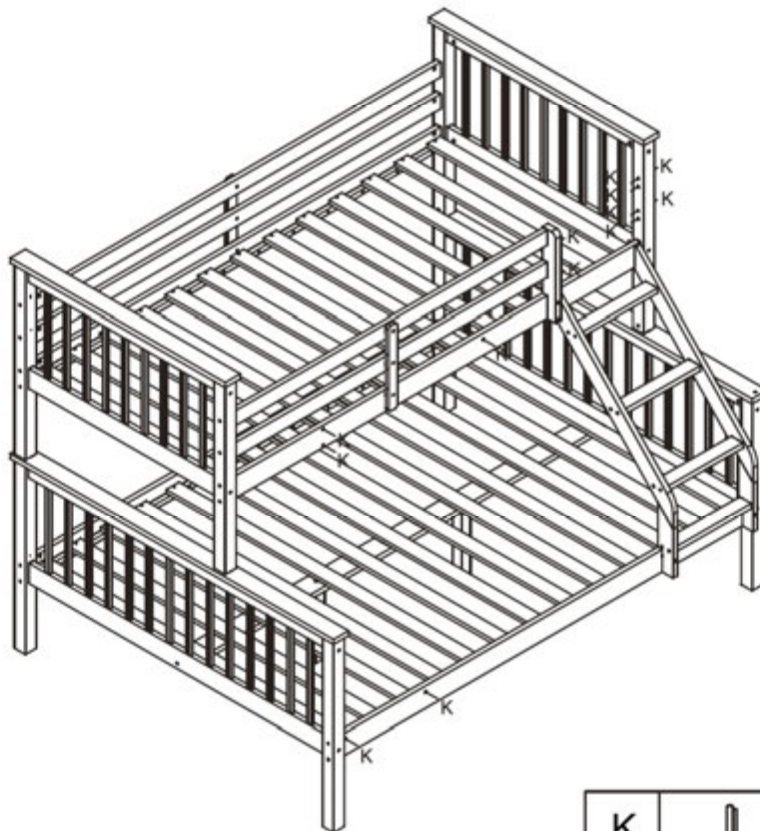

K	  Ø8mm	13
---	---	----