

# ASSEMBLY INSTRUCTION 7048B

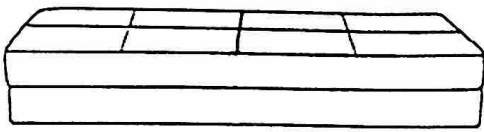

A\*1

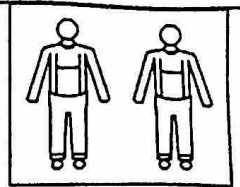
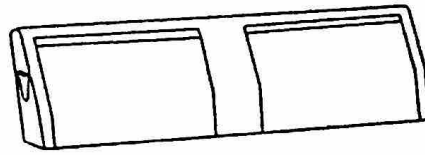

B\*1

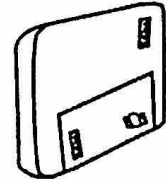

C\*2

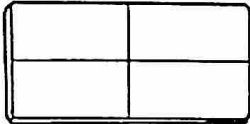

D\*2

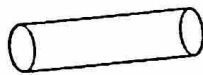

E\*2

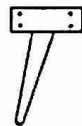

F\*4



G\*16

## STEP 1

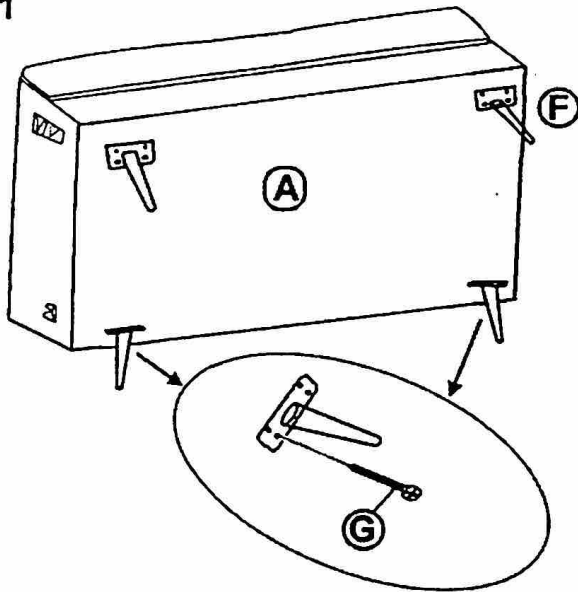

## STEP 2

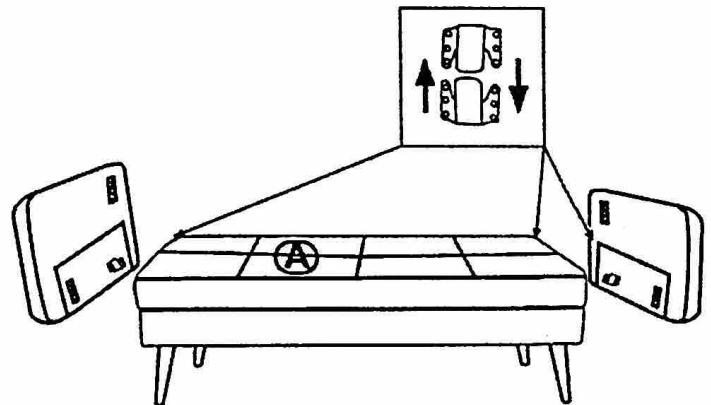

## STEP 3

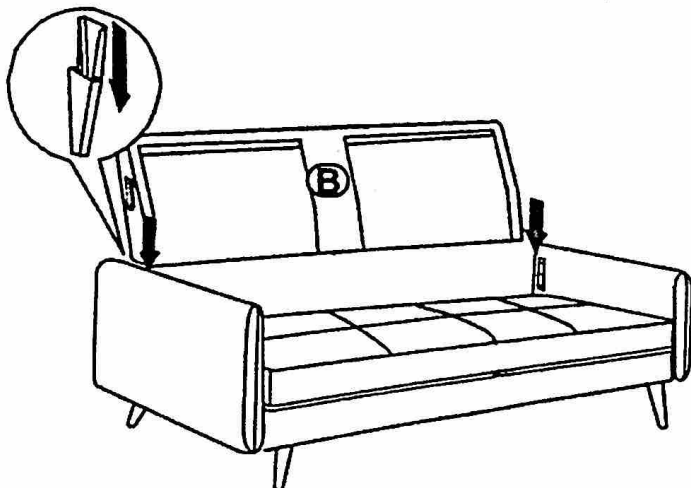

## STEP 4

