

Atenção! Attention! ¡Atención!

Atenção! Com os pés, não arraste o balcão para evitar danos. Movimente com cuidado.
Attention! With the feet, do not drag the counter to avoid damage. Move with care.
¡Atención! Avec les pieds, ne traitez pas le comptoir pour éviter les dommages. Déplacez avec précaution.
¡Atención! Con las piezas, no arrastre el mostrador para evitar daños. Muévalo con cuidado.

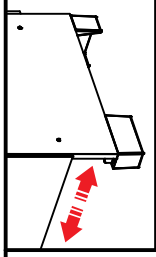

ACCESÓRIOS / ACCESSORIES / ACCESSOIRES

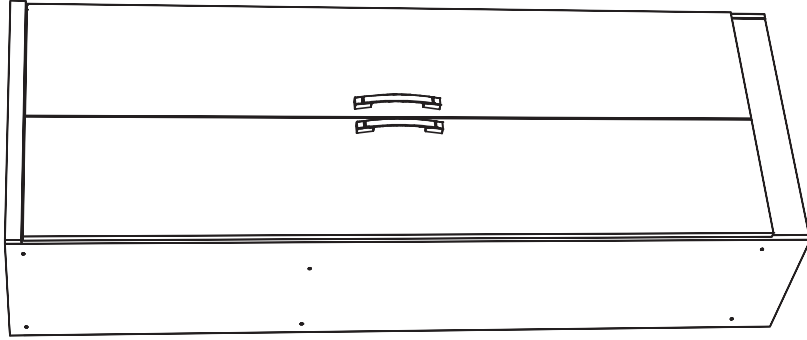
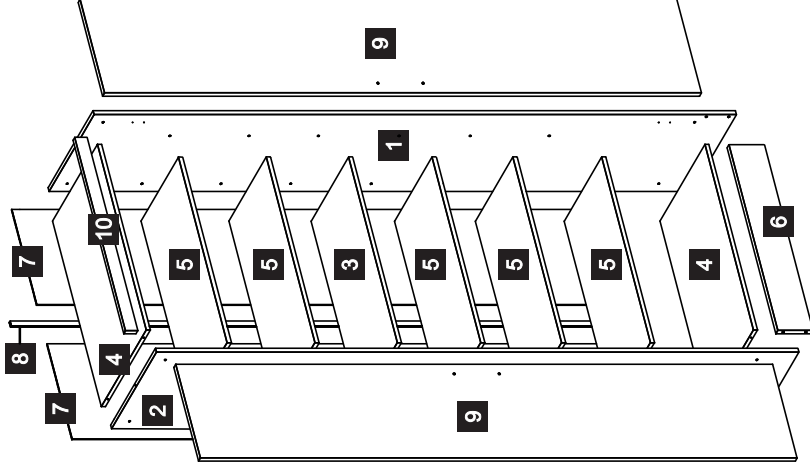
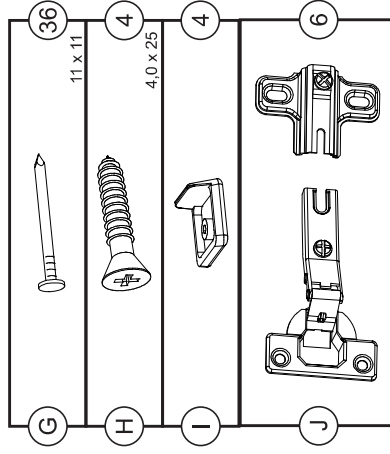
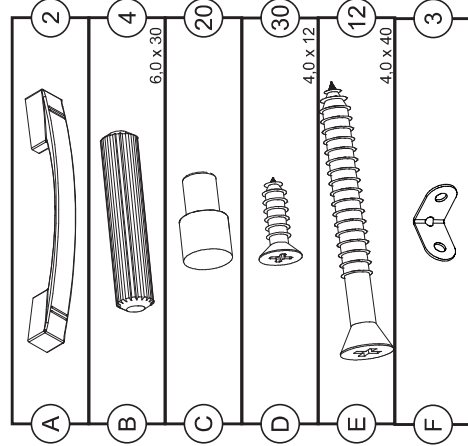

LISTA DE PEÇAS / PARTS LIST / LISTA DE PEÇAS / LISTE DES PIÈCES

#	Piezas	Pieces	Peças	Pièces	Peças	Pièces	Quantidade
1	Lateral Derecha	Right Side Panel	Lateral Direita	Côté Droit	Lateral Esquerda	Côté Gauche	1820 x 360 x 12
2	Lateral Izquierda	Left Side Panel	Lateral Esquerda	Côté Gauche	Prateleira Fixa	Étagère Fixe	1820 x 360 x 12
3	Repisa Fija	Fixed Shelf	Prateleira Fixa	Étagère Fixe	Base/Tampo	Fond/Pièce du Dessus	583 x 300 x 12
4	Base/Tampo	Base/Top	Base/Tampo	Fond/Pièce du Dessus	Prateleira Móvel	Étagère Mobile	583 x 360 x 12
5	Repisa Móvil	Movable Shelf	Prateleira Móvel	Étagère Mobile	Rodapé	Socle	583 x 300 x 12
6	Zócalo	Baseboard	Rodapé	Socle	Costa	Pièce Arrière	583 x 100 x 15
7	Costado	Back Panel	Costa	Pièce Arrière	Perfil	Profil	1700 x 299 x 3
8	Perfil	Profile	Perfil	Profil	Porta	Porte	1658mm
9	Puerta	Door	Porta	Porte	Moldura	Cadre	1691 x 294 x 15
10	Marco	Frame	Moldura	Cadre			607 x 35 x 15



HERRAMIENTAS
HARDWARE
FERRAMENTAS
OUTILS

PERSONAS NECESARIAS PARA EL MONTAJE
PEOPLE REQUIRED FOR ASSEMBLY
PESSOAS NECESSÁRIAS PARA A MONTAGEM
NOMBRE DE PERSONNES NÉCESSAIRES
A L'ASSEMBLAGE



Consejos de Conservación

1. No debe utilizarse en la limpieza, abrasivos como lana de acero, alcohol, limón, o productos corrosivos que puedan rayar o quita la película en los muebles.
2. Cuando la limpieza de muebles en general, napa y formica, deben utilizarse un paño ligeramente humedecido y jabón suave.
3. Para mover el mueble, es importante que este se eleve desde el suelo, debido a que el arrastre puede causar daño estructural.
4. No deje el mueble en exposición a la intemperie.

Conservation Tips

1. Do not use abrasive products to clean such as steel wool, alcohol, vinegar, lemon, scouring powder, or corrosive products which can scratch or peel off the protective film of the furniture.
2. The best way to clean your furniture is to use a slightly moistened cloth with a mild soap.
3. To move the furniture assembled, it is important that it is lifted off the ground, because the drag it can cause structural damage.
4. Do not leave your furniture in weather exposure.

Dicas de conservação

1. Não utilizar na limpeza abrasivos tais como: palha de aço, álcool, vinagre, limão, saponáceo ou produtos corrosivos que possam riscar ou descolar a película protetora dos móveis.
2. Na limpeza de móveis em geral, napas e fórmicas, deve ser utilizado um pano levemente umedecido e sabão neutro.
3. Para a movimentação do móvel, é importante que este seja levantado do chão, pois ao arrastá-lo pode causar avarias estruturais.
4. Não deixe o móvel em exposição a intempéries.

Conseils d'entretien

1. Ne pas utiliser de produits abrasifs dans le nettoyage, tels que: laine d'acier, alcool, vinaigre, citron, poudre à récurer ou autres produits corrosifs pouvant rayer ou faire décoller la pellicule protectrice des meubles.
2. Pour le nettoyage du meuble, il est recommandé d'utiliser un chiffon humide et du savon neutre.
3. Pour déplacer le meuble, il est important de le soulever du sol car le tirer pourrait causer des dommages dans sa structure.
4. Ne pas exposer le meuble aux intempéries.

PESO POR TAPA

Por favor, preste atención a los pesos máximos admitidos por cada compartimiento del producto. Tenga cuidado de no exceder estos pesos, con el fin de garantizar la calidad y durabilidad del producto. Es importante recordar que los pesos muestran en caso de ser **DISTRIBUIDA** en toda el área de la plataforma.

WEIGHT PER TOP















Please pay attention to the maximum weights supported by each compartment product. Be careful not to exceed these weights, in order to ensure the quality and durability of the product. It is important to remember also that the weights shown should be **DISTRIBUTED** throughout the area of the shelf.

PESO POR TAMPO

Por favor, preste atenção aos pesos máximos suportados por cada compartimento do produto. Cuidado para não exceder esses pesos, afim de garantir a qualidade e a durabilidade do mesmo. É importante lembrar também que, os pesos mostrados devem ser **DISTRIBUÍDOS** ao longo de toda a área da peça.

POIDS PAR TOP

Veillez faire attention aux poids maximums supportés par chaque produit du compartiment. Veillez à ne pas dépasser ces poids, afin de garantir la qualité et la durabilité du produit. Il est également important de se rappeler que les poids indiqués doivent être **RÉPARTIS** sur toute la surface du rayon.

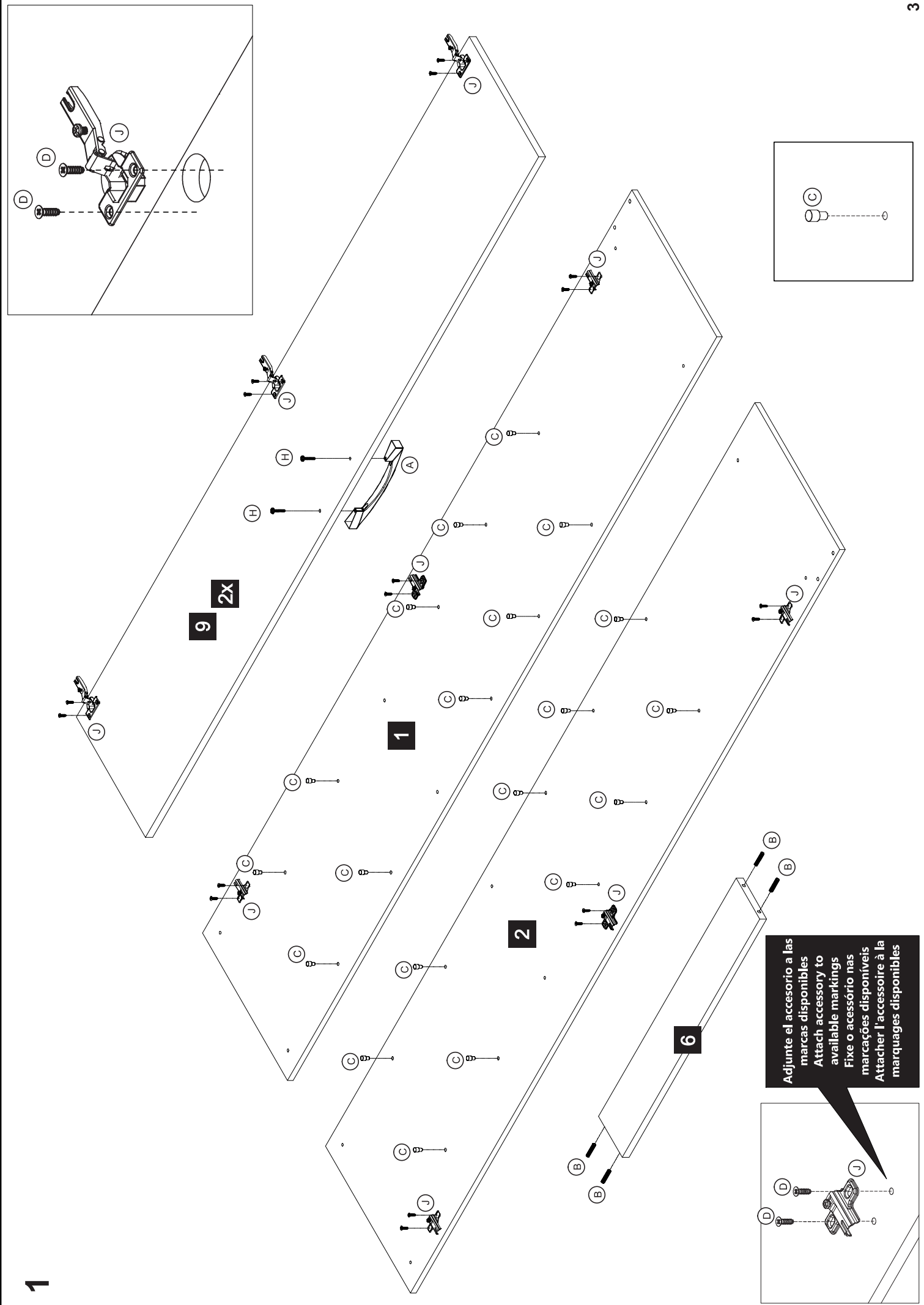

1

9 2x

1

2

6

Adjunte el accesorio a las
 marcas disponibles
 Attach accessory to
 available markings
 Fixe o acessório nas
 marcações disponíveis
 Attacher l'accessoire à la
 marquages disponibles

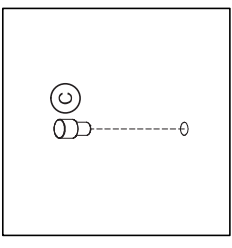
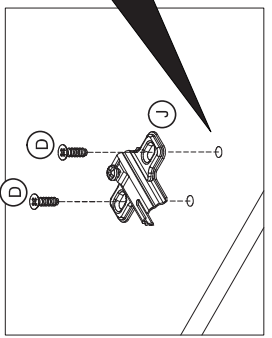

3

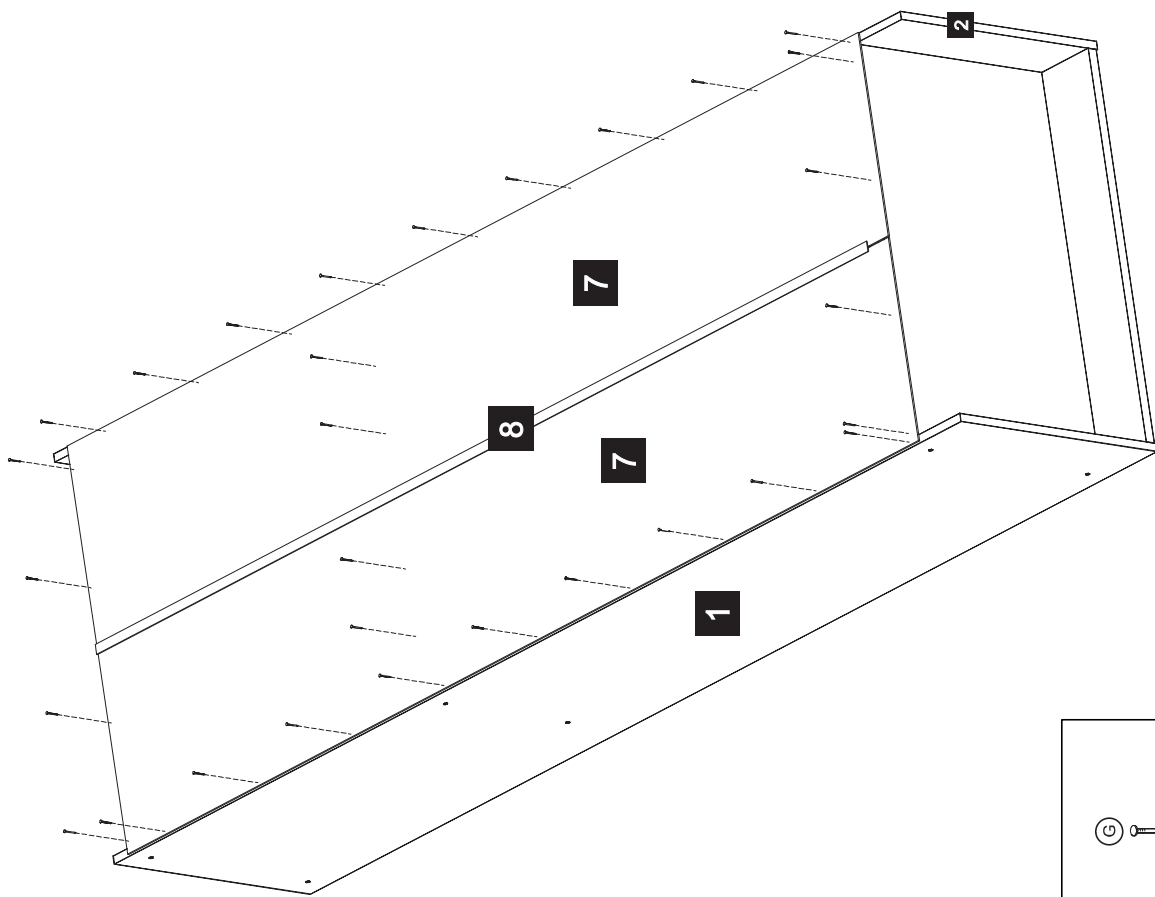

2

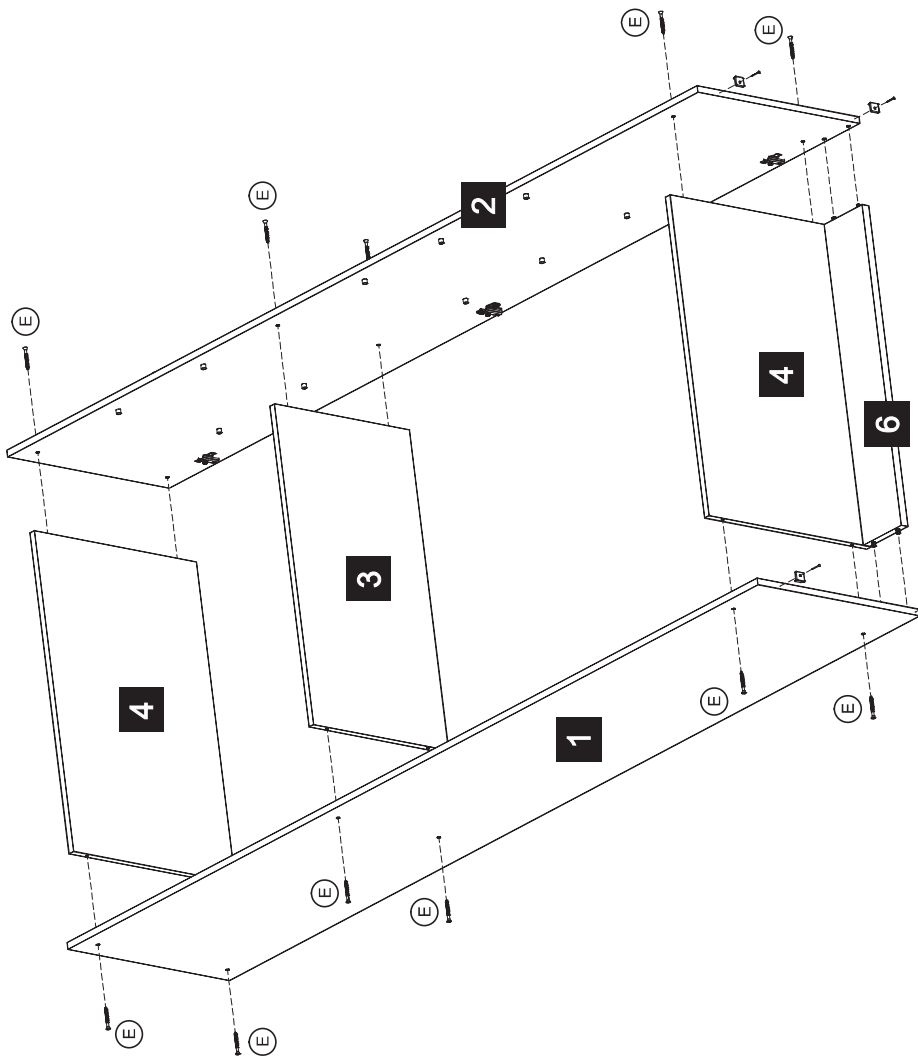

Ajuste da Porta / Door Adjustment / Ajuste de la Puerta / Réglage des charnières de la porte

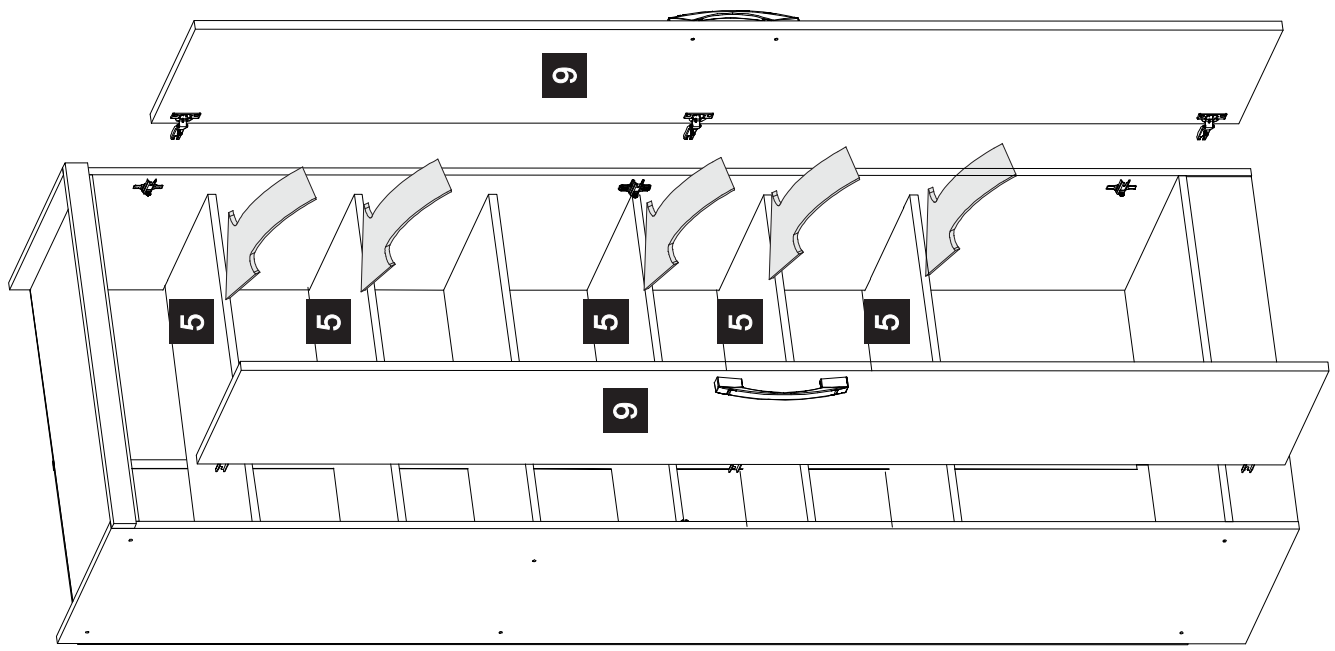
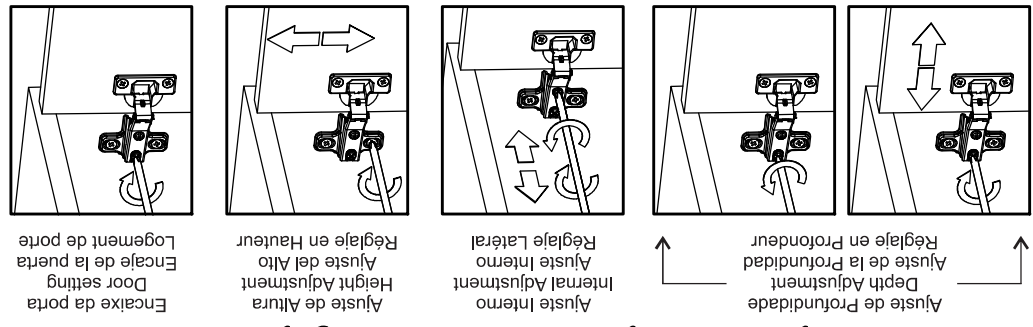

5

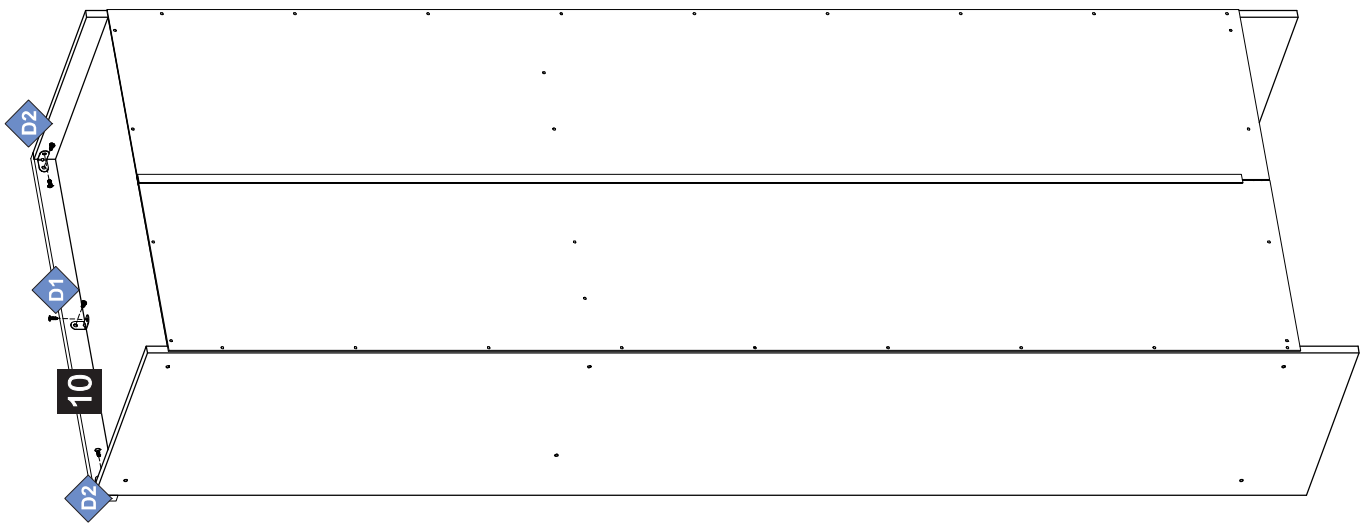
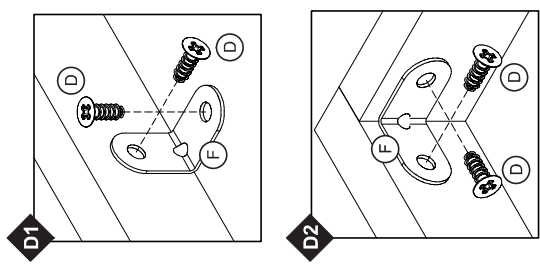

4