

ATENÇÃO:

1. Ler e observar atentamente toda a instrução antes de iniciar a montagem.
2. A montagem do produto deverá ser feita em uma superfície limpa e plana. Aconselhamos utilizar a embalagem para forrar o chão, a fim de não danificar o produto.

ATENCIÓN:

1. Leer y observar con mucha atención toda la instrucción antes de empezar el montaje.
2. El montaje del producto deberá ser hecho en una superficie limpia y plana. Aconsejamos poner el embalaje del producto en el suelo de manera a no dañar el producto.

ATTENTION:

1. Please, read and check carefully the whole instruction before assembling.
2. The assembly should be carried out on a clean and flat surface. We suggest you use the packaging to cover the floor in order to do not damage it and the product.

LIMPEZA:

1. Utilize pano levemente umedecido com água, seguido de pano seco.
2. Não utilizar produtos químicos.

LIMPIEZA:

1. Utilizar un paño húmedo con agua y después pasar un paño seco.
2. No utilizar productos químicos o abrasivos.

CLEANING:

1. Use a slightly wet cloth followed by a dry one.
2. Do not use chemical or abrasive products.

Ferramentas Necessárias/Herramientas Necesarias/Tools Required (não fornecidas) (no suministradas) (not supplied)

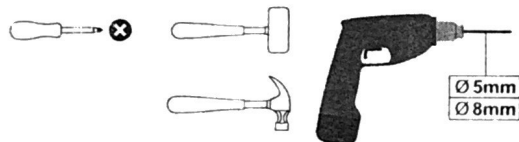

Pessoas necessárias para a montagem
Personas necesarias para montaje
People required for assembly



#	Qtd/Cd/Qt	Português	Español	English
01	1	Base Balcão	Base Balcón	Counter Base Panel
02	1	Tampo Balcão	Tapa Balcón	Counter Top Panel
03	1	Lateral Direita Inferior	Lateral Derecha Inferior	Lower Right Side Panel
04	1	Lateral Esquerda Inferior	Lateral Izquierda Inferior	Lower Left Side Panel
05	1	Prateleira Reduzida Balcão	Repisa Menor Balcón	Counter Small Shelf
06	2	Porta Balcão	Puerta Balcón	Counter Door
07	2	Costa Balcão	Costado Balcón	Counter Back Panel
08	2	Base-Tampo Aéreo	Base-Tapa Armario	Cupboard Base-Top
09	1	Lateral Direita Superior	Lateral Derecha Superior	Upper Right Side
10	1	Lateral Esquerda Superior	Lateral Izquierda Superior	Upper Left Side
11	1	Prateleira Reduzida	Repisa Menor	Small Shelf
12	2	Porta Aéreo	Puerta Armario	Cupboard Door
13	2	Costa Aéreo	Costado Armario	Cupboard Back Panel

FERRAGENS / HERRAJES / HARDWARE

A		48	I		44
B		06	J		02
C		12	K		04
D		20	L		08
E		08	M		04
F		04	N		02
G		20	O		04
H		08			

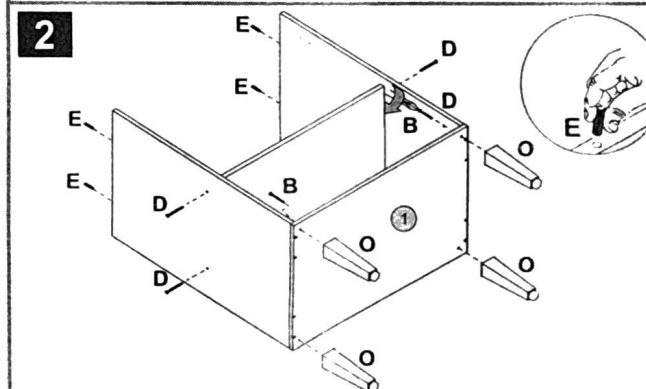
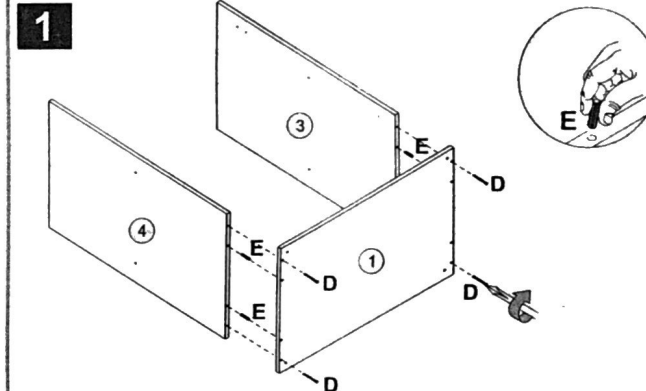

3

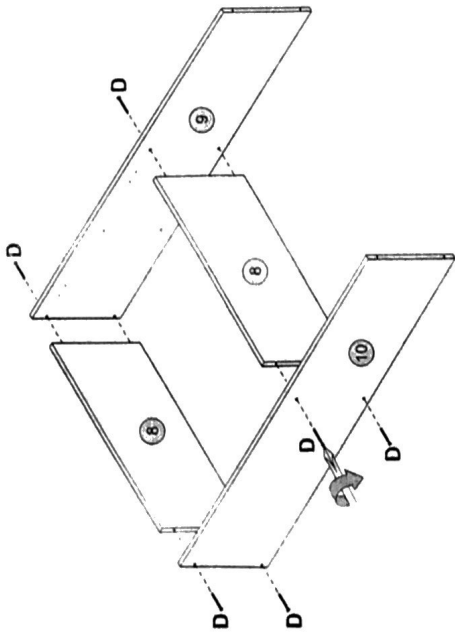

6

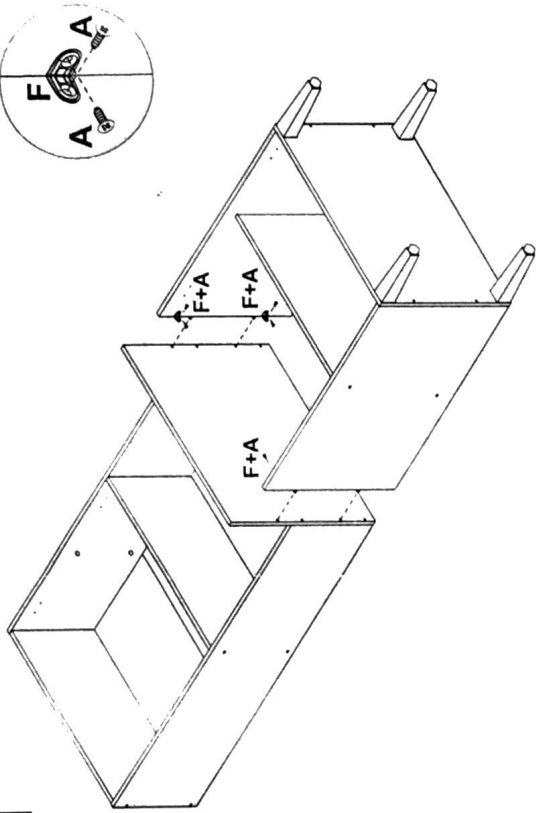

9

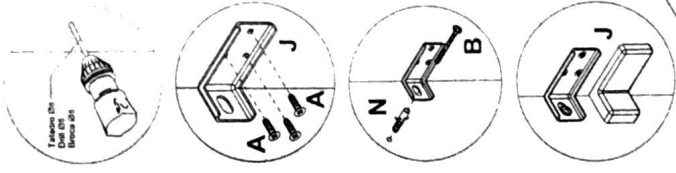

4

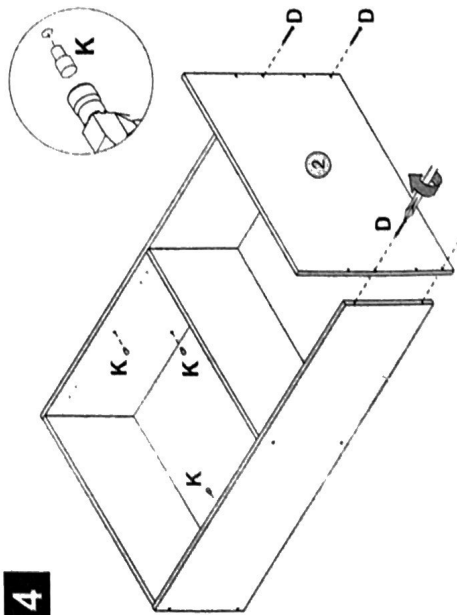

7

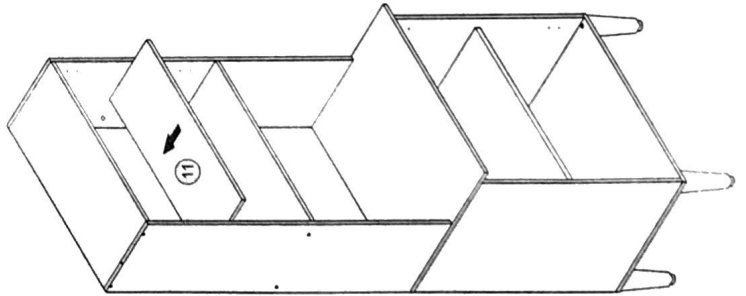

8

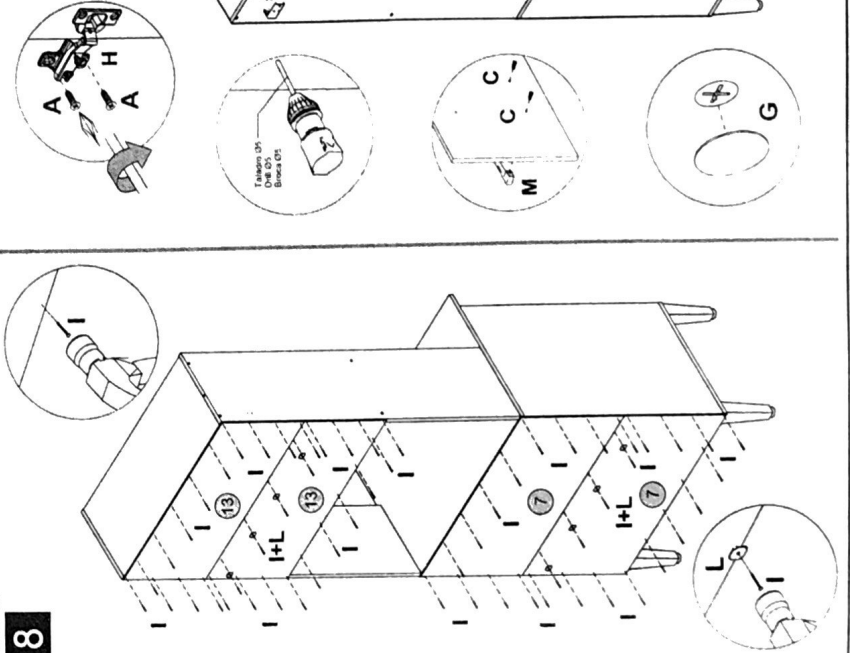

5

