

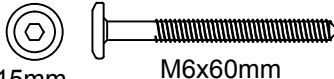







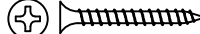

## HARDWARE

|   |   |    |   |  |    |
|---|---|----|---|--|----|
| A | <br>15mm M6x60mm | 04 | F |                   | 08 |
| B |                | 04 | G |                 | 01 |
| C | <br>Ø8x30mm    | 24 | H | <br>8mm Ø4x30mm  | 30 |
| D |                | 08 | I | <br>Ø15x2mm     | 08 |
| E |                | 08 | J | <br>15mm Ø6x70mm | 04 |

01

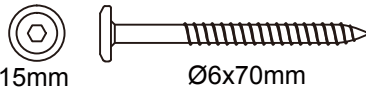
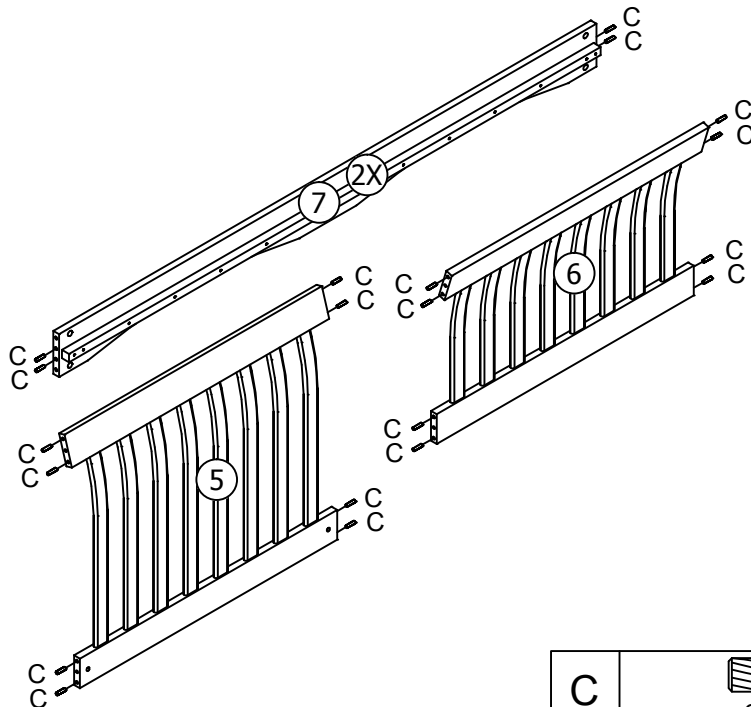



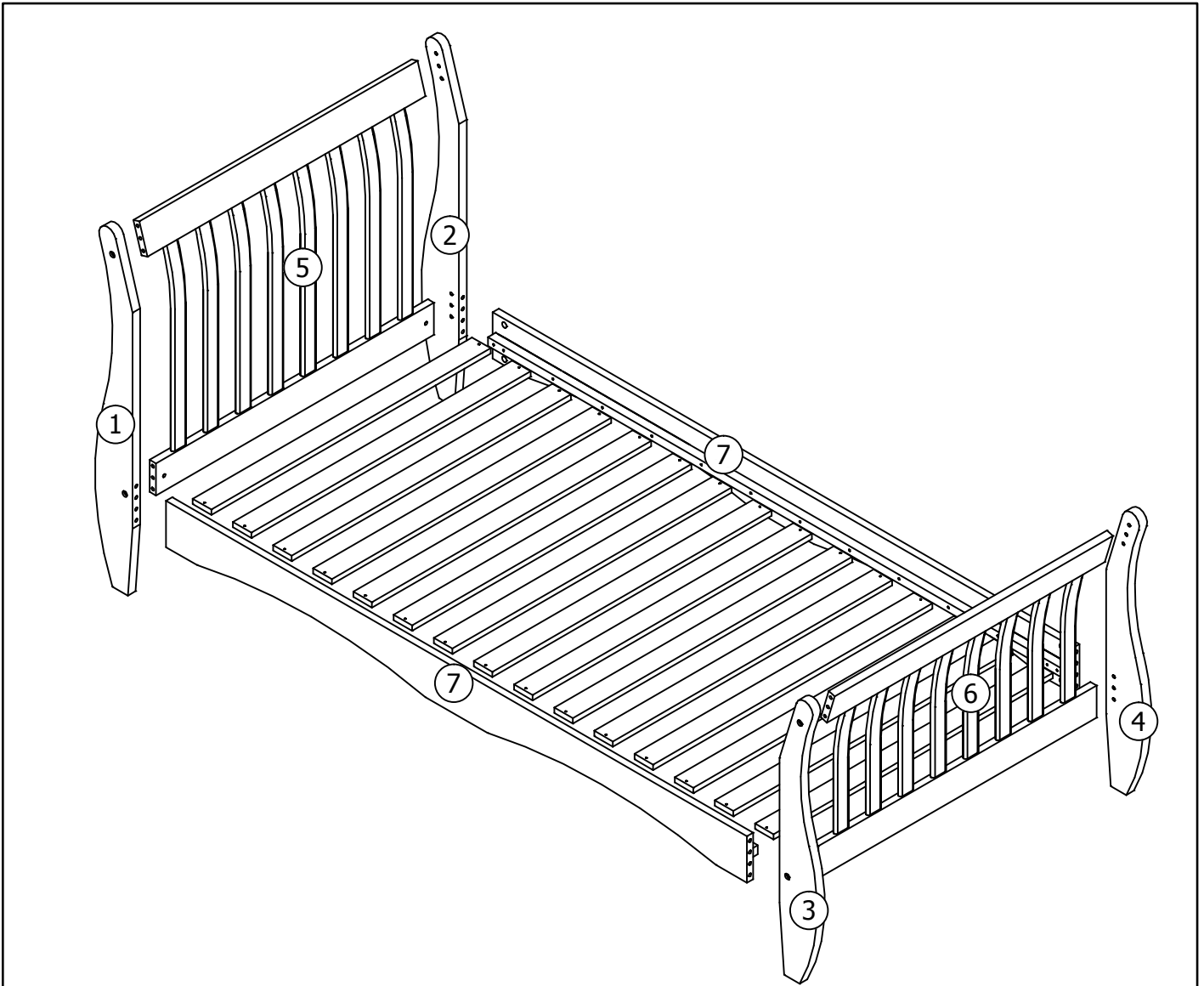

|   |  |    |
|---|--|----|
| C | <br>Ø8x30mm | 24 |
|---|--|----|

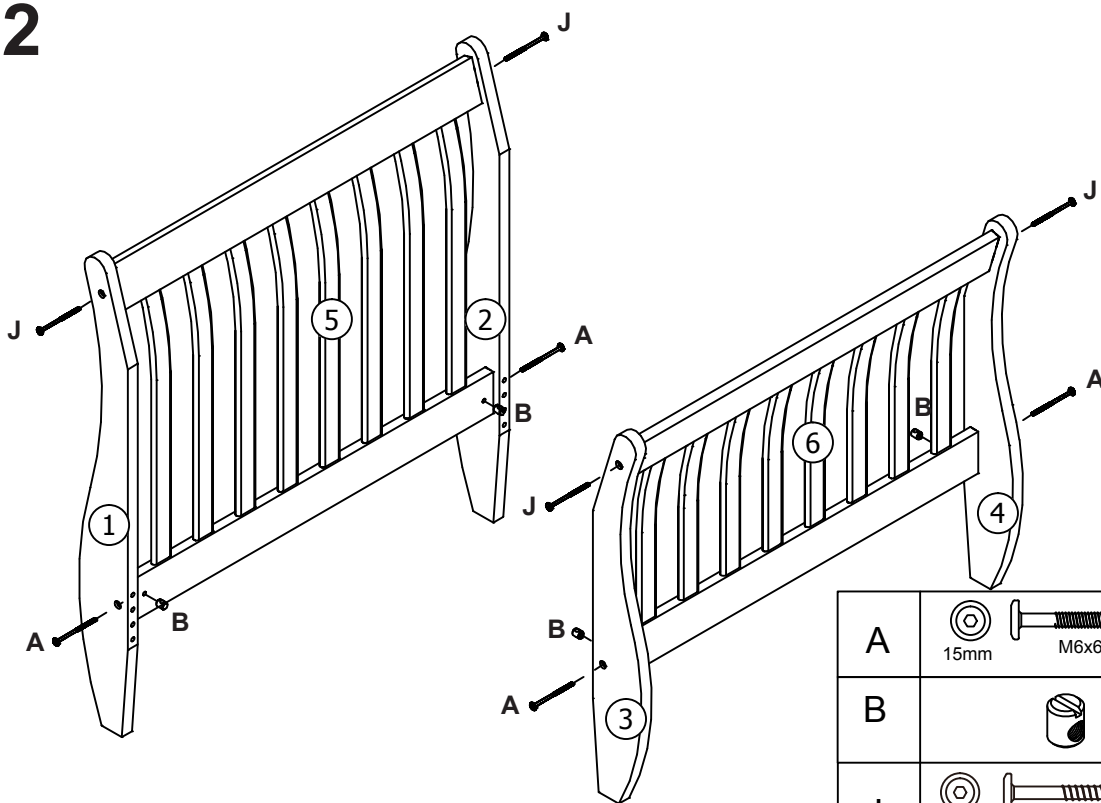

# 02

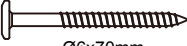

|   |   |  |    |
|---|---|--|----|
| A | <br>15mm | <br>M6x60mm | 04 |
| B |          |  | 04 |
| J | <br>15mm | <br>Ø6x70mm | 04 |

03

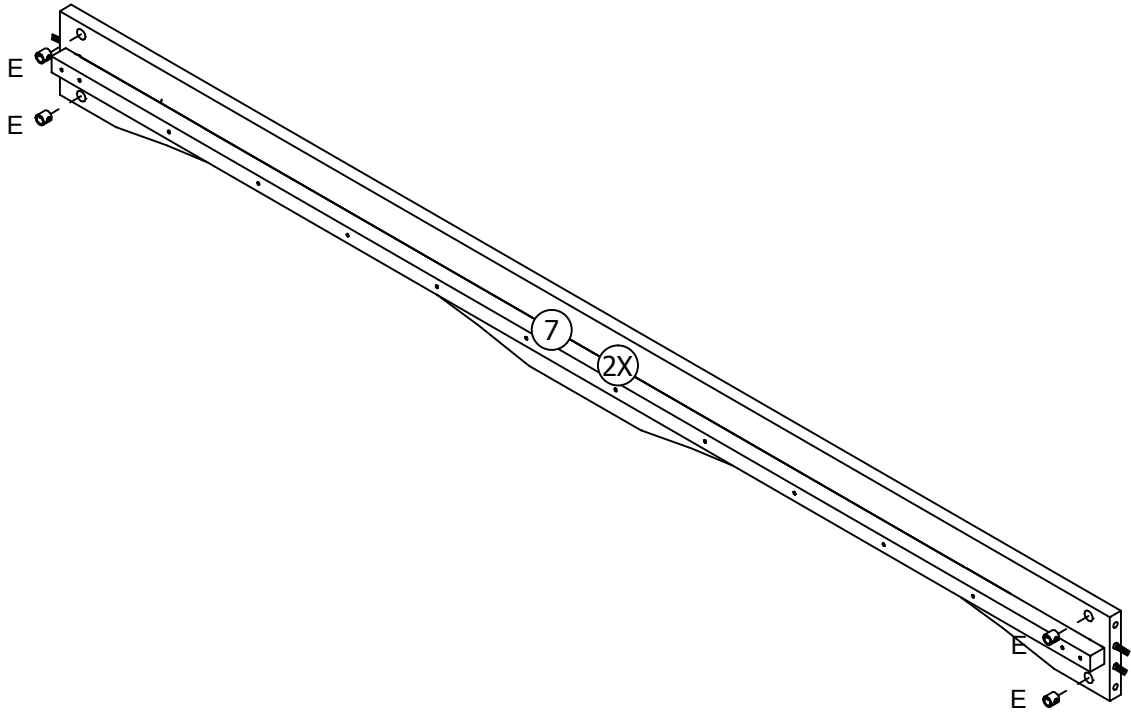

E



08

04

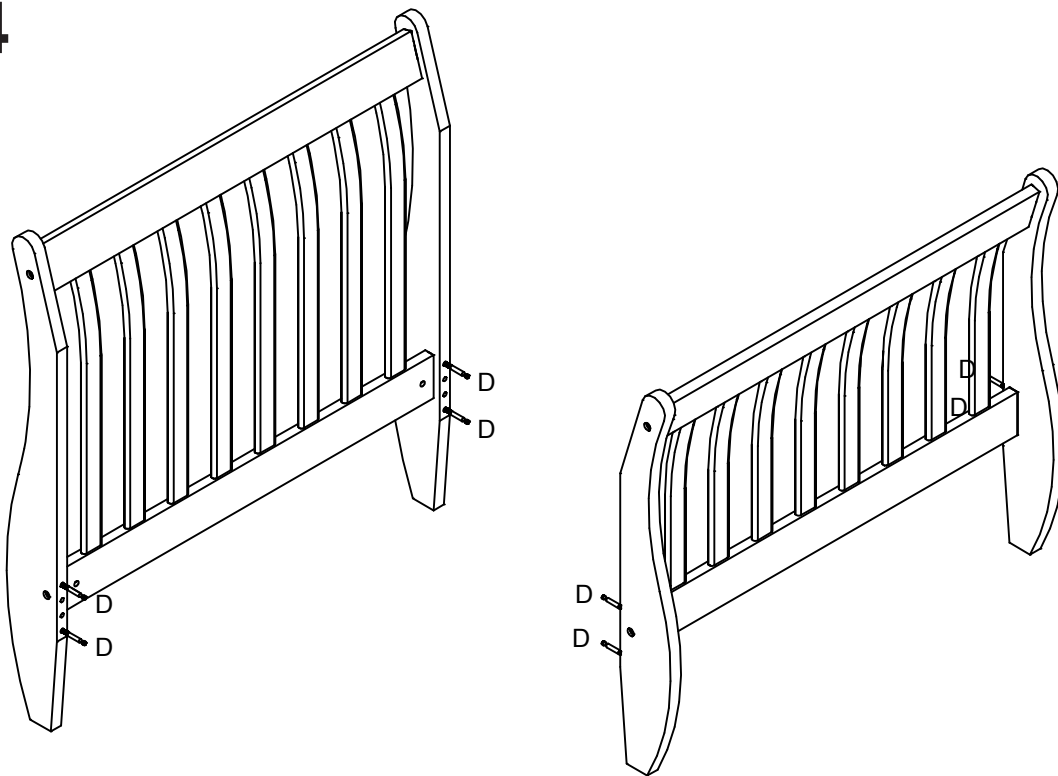

D

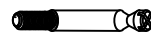

04

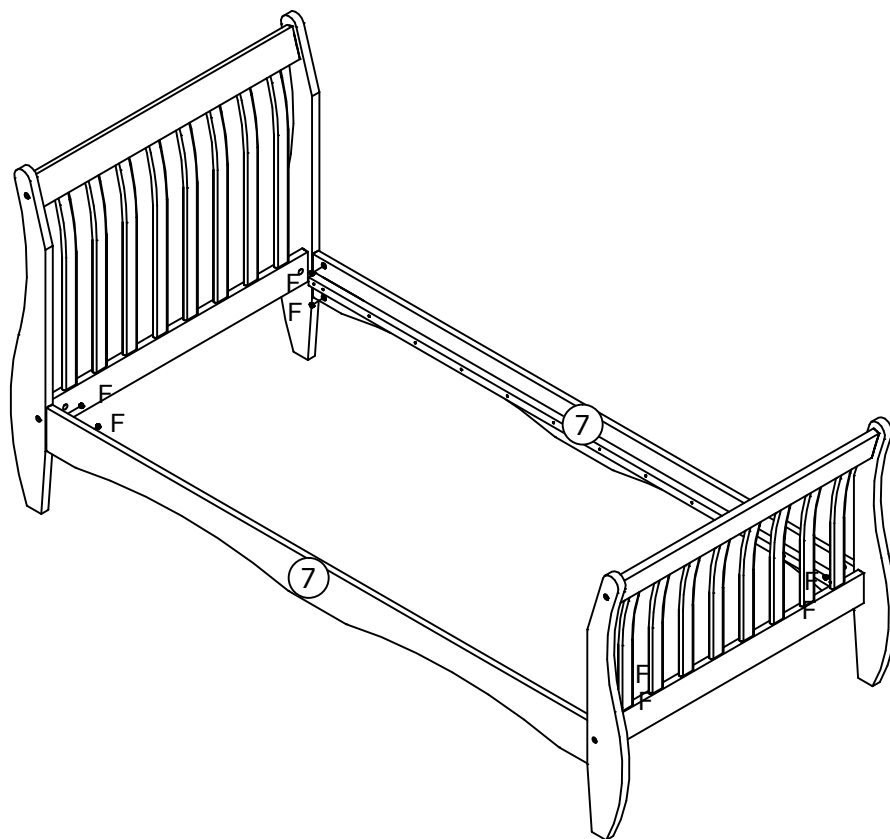

05

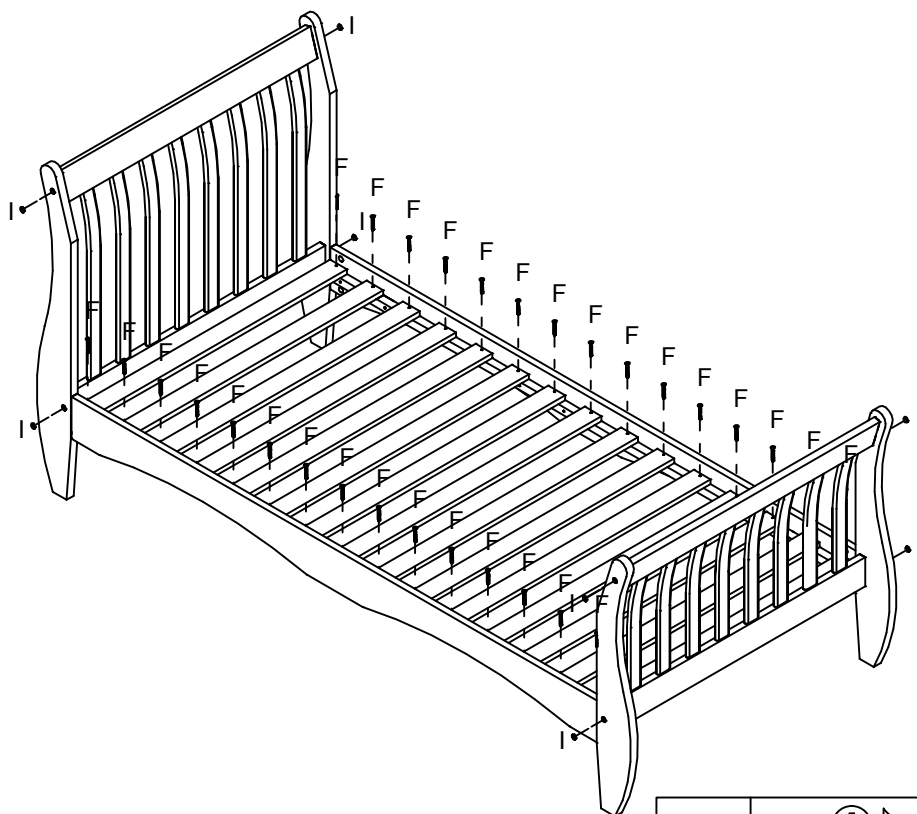

|   |   |    |
|---|---|----|
| F |  | 08 |
|---|---|----|

06



|   |   |    |
|---|---|----|
| H |  8mm Ø4x30mm   | 30 |
| I |   Ø15x2mm | 08 |