

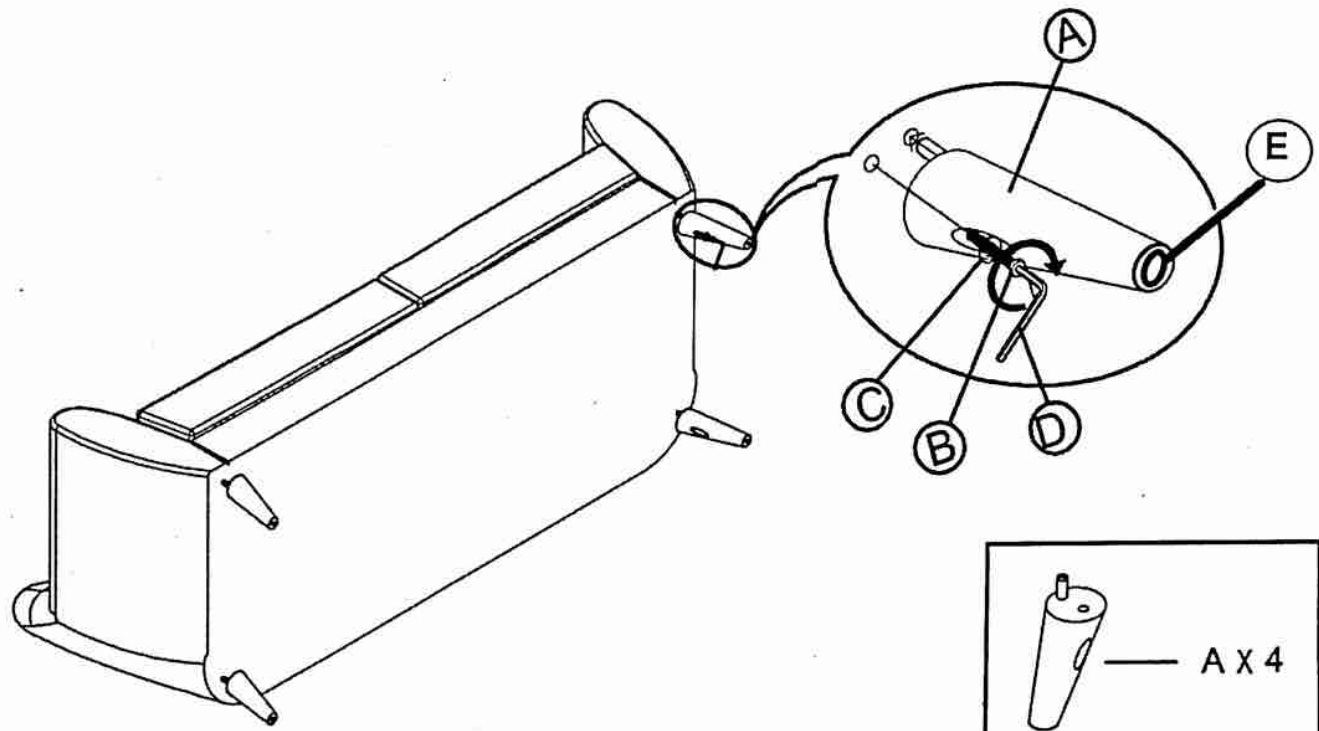

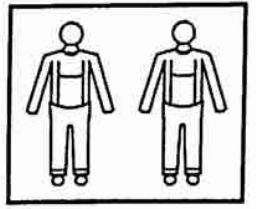



# ASSEMBLY INSTRUCTION



-  — A X 4
-  — B X 4
-  — C X 4
-  — D X 1
-  — E X 4

